

5 DOOR BIFOLD DOOR SET "532"

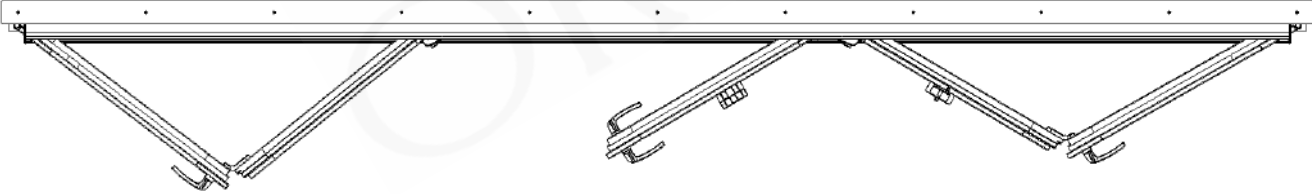

Hardware

A. 6 x 140 mm Screw x **10**

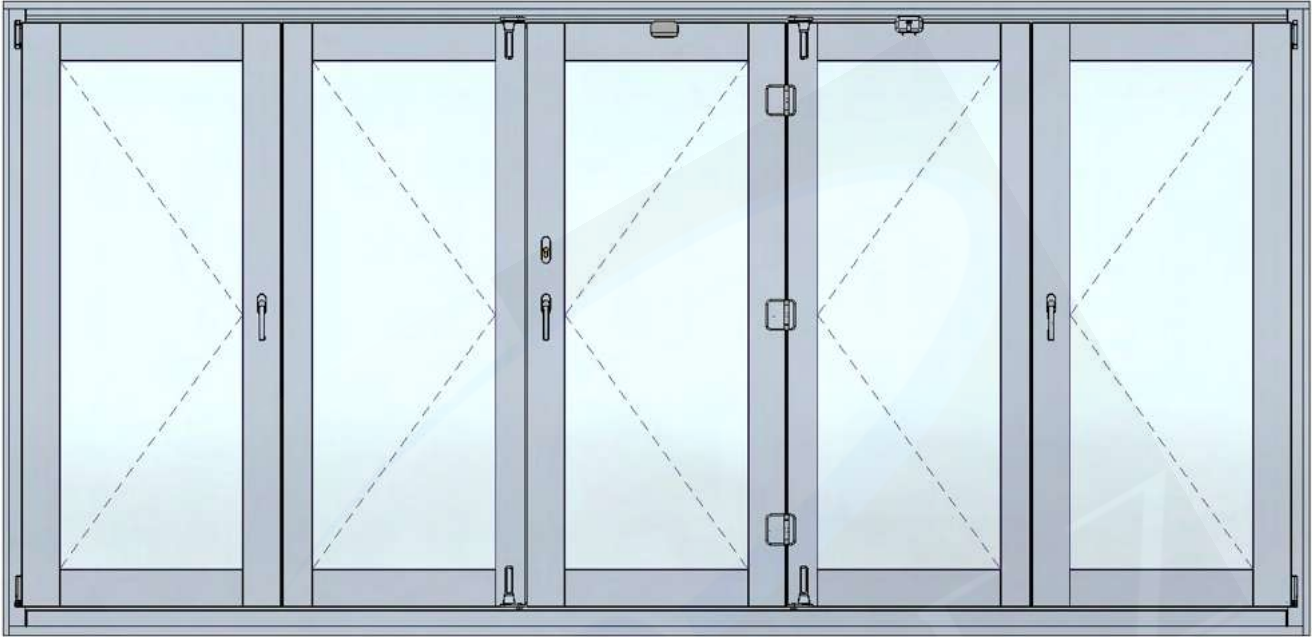

B. 3,5 x 40 mm Screw x **61**



C. Plastic push x **18**



D. Upper guide roll x **2**



E. Lower guide roll x **2**

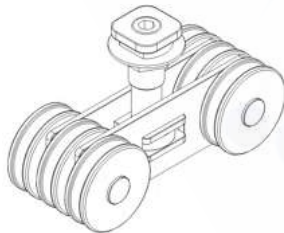

F. Lock set

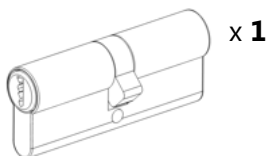
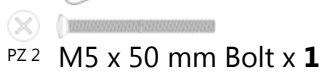

G. Open-end spanner SW17 x **1**



H. Plastic cover x **1**

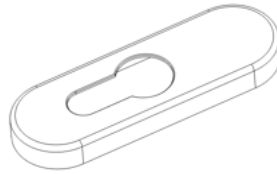

I. CB rosette inside x **1**

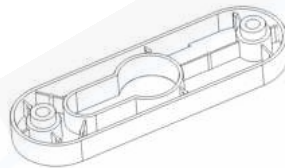
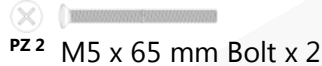

J. CB rosette outside x **1**

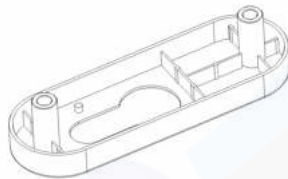

K. Cover cap x **9**



L. Cover cap x **9**

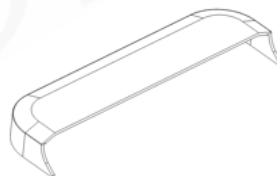

M. Cover cap for stay hinge x **2**



Pins (x 11) are pre-installed



N. Cover cap for stay bearing x **2**

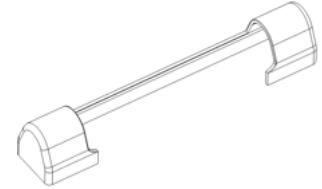

O. Cover cap x **1 RH** + x **1 LH**



P. Cover cap for pivot rest x **2**



R. Turn handle x **2**

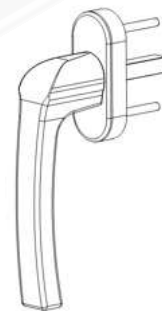

S. Turn handle set

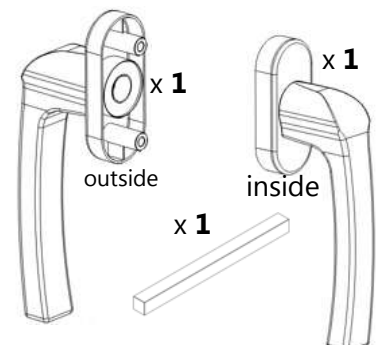
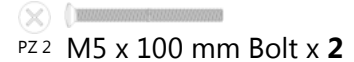

Parts list

LH
x 1

RH
x 1

x 4

x 2

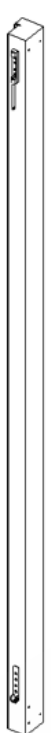

x 1

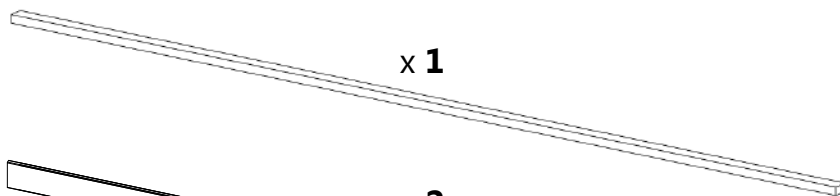

x 2

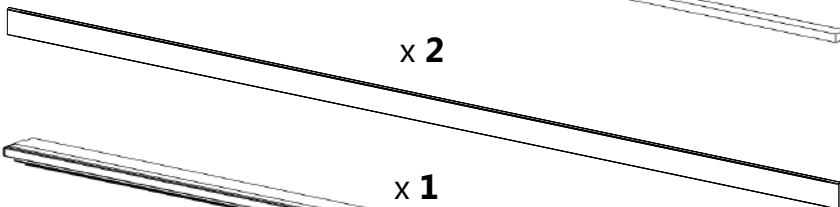

x 1

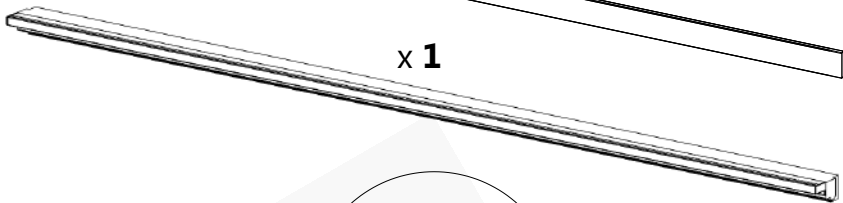

TOP

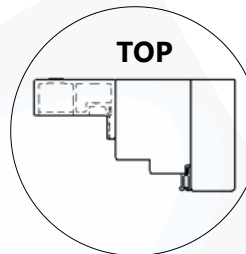

x 1

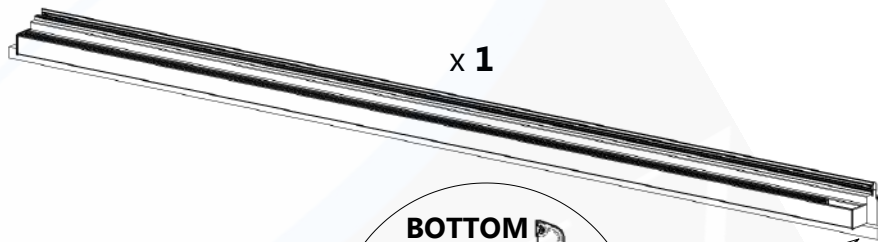

BOTTOM

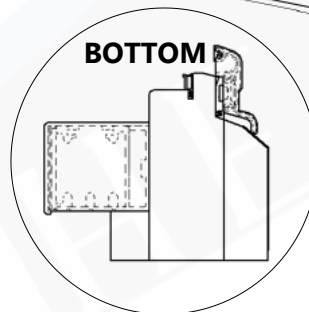

x 1

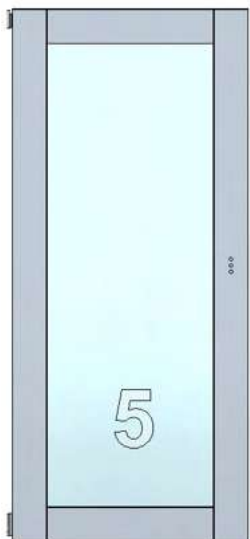

x 1

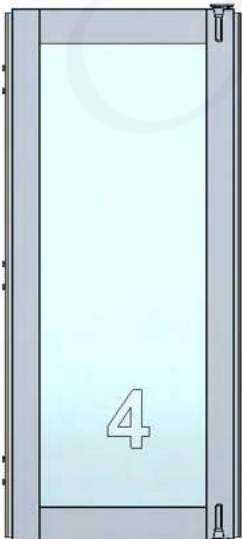

x 1



x 1

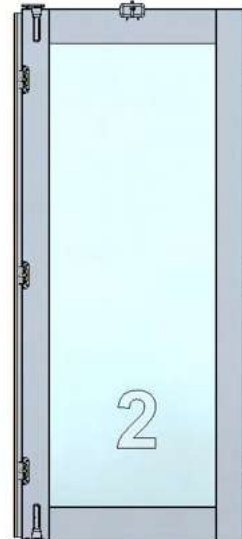

x 1

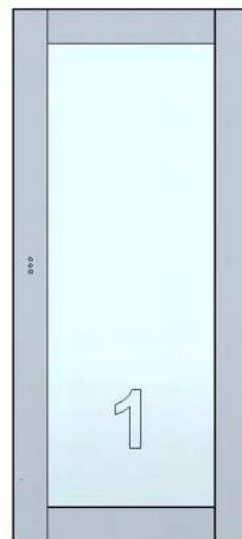

Door frame assembling



□ Lay the 4 pcs of frame parts on the floor on top of cardboard or a similar protective material to prevent damage to the parts.



TX 30

Tools not supplied!

A. 6 x 140 mm Screw x 10

Step 1

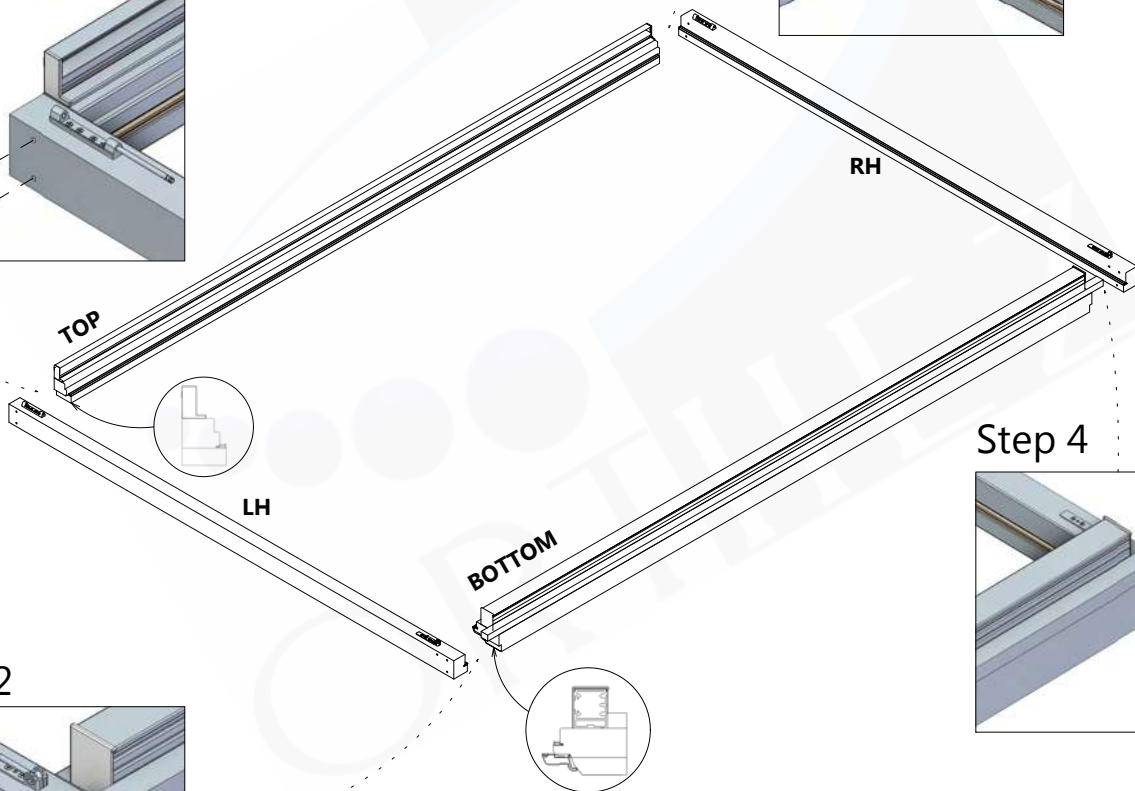
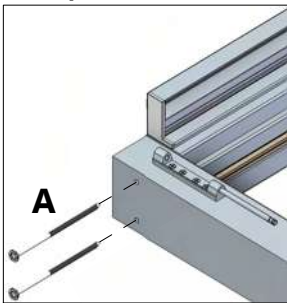

Step 3

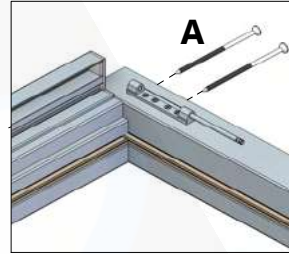

Step 4

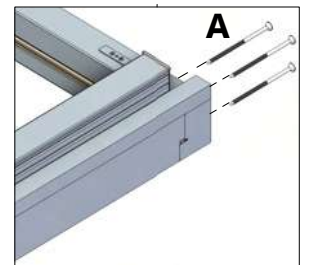

Step 2

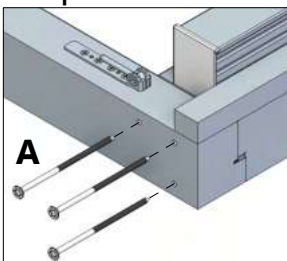

Filling bar assembling



TX 15

Tools not supplied!

B. 3,5 x 40 mm Screw x 21



Note!

Variations depending on wall thicknesses:

- filling bars **are** assembled by the factory
- filling bars **are not** assembled, follow instructions below

Step 1

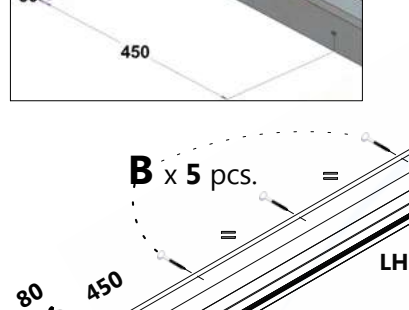
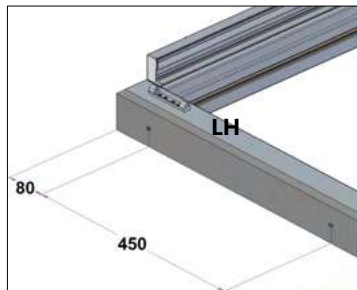

B x 5 pcs.

LH

Step 3

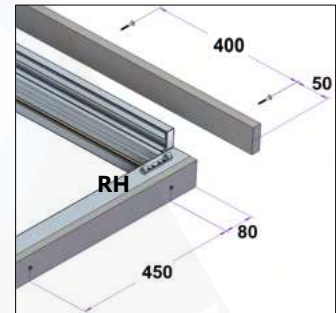

B x 11 pcs.

RH

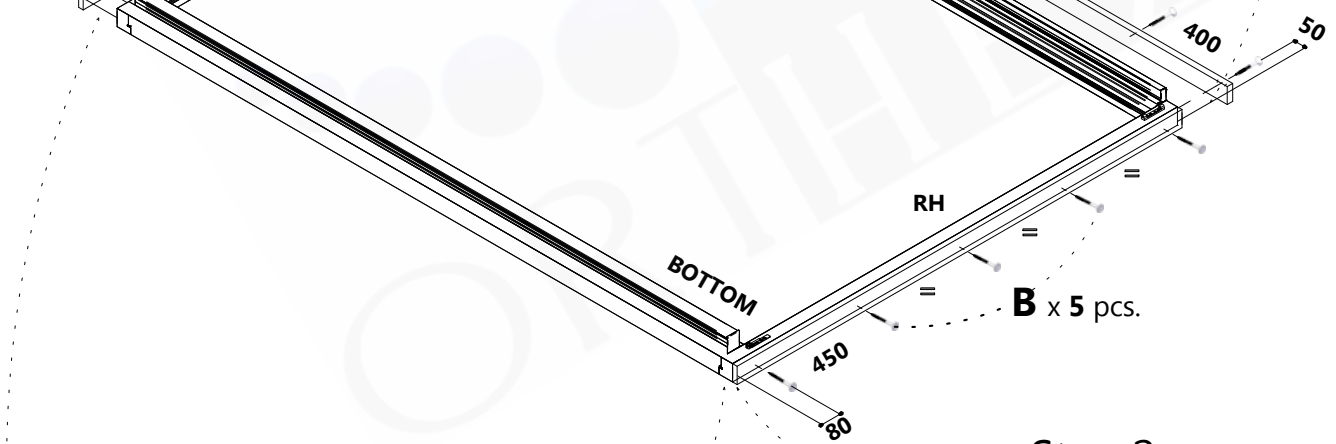

B x 5 pcs.

RH

Step 2

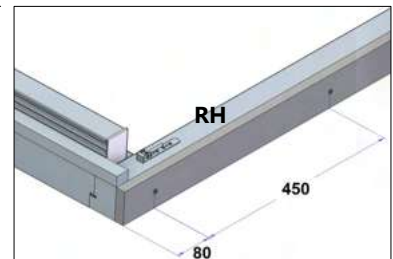
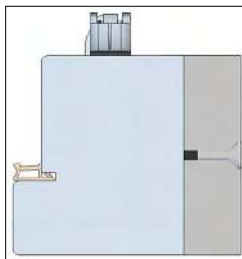
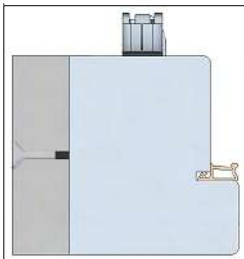

Door frame installation and sideboard fixing



Tools not supplied!

B. 3,5 x 40 mm Screw x 40

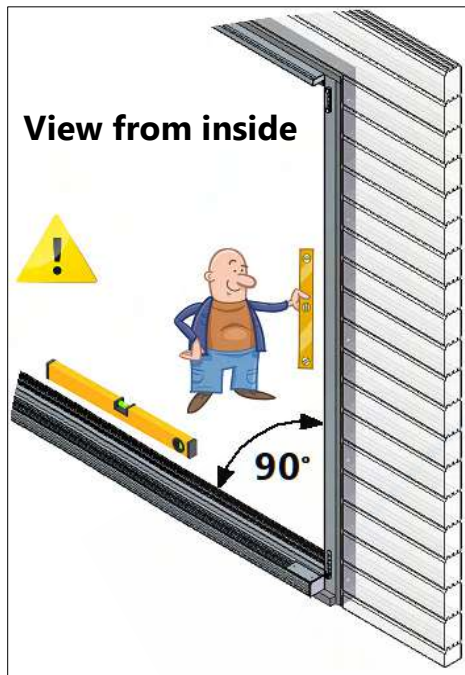

Step 1



Step 2

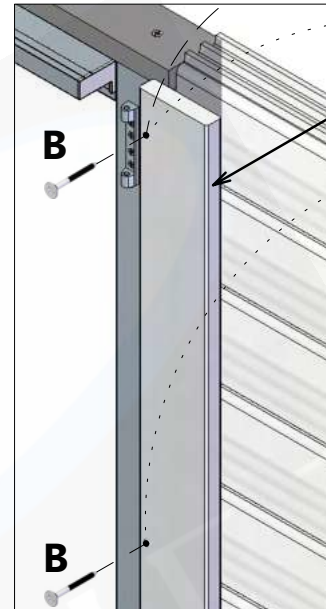

vertical sideboard

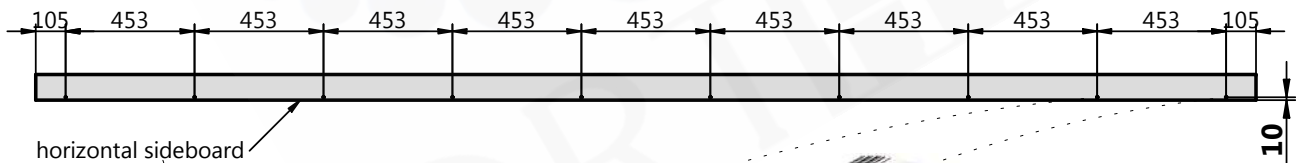

Step 3

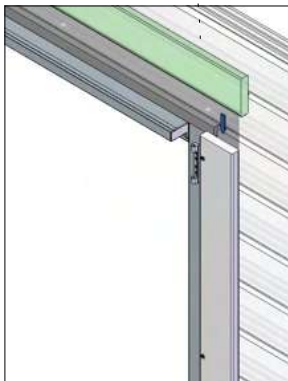

Step 4

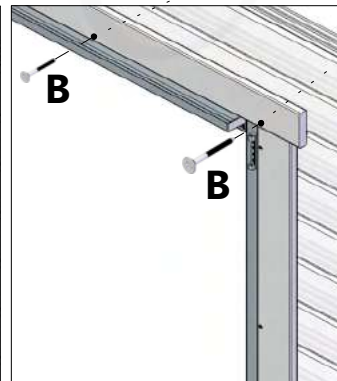

Step 5

Perform same steps exterior side

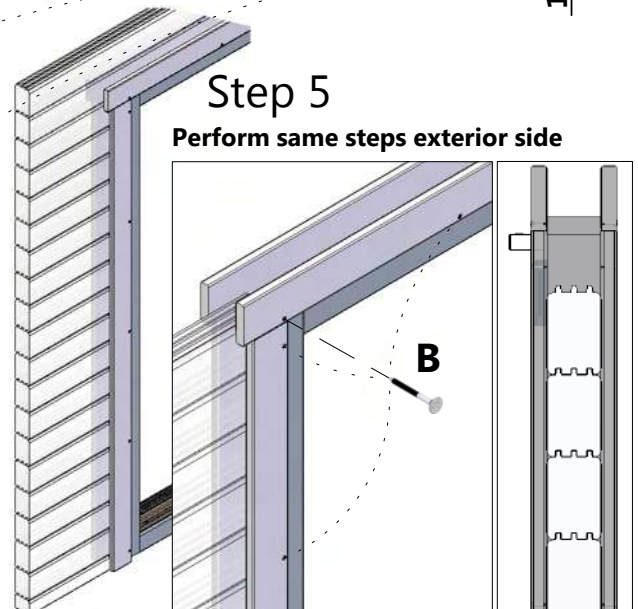

Door sash no. 1 installation



See the page 16

- engaging and disengaging the stay
- adjusting the stay
- adjustment at the rebate corner hinge
- adjusting the pivot rest

View from inside

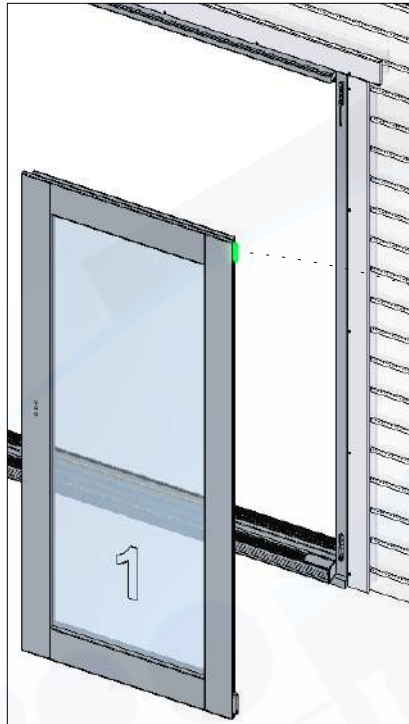
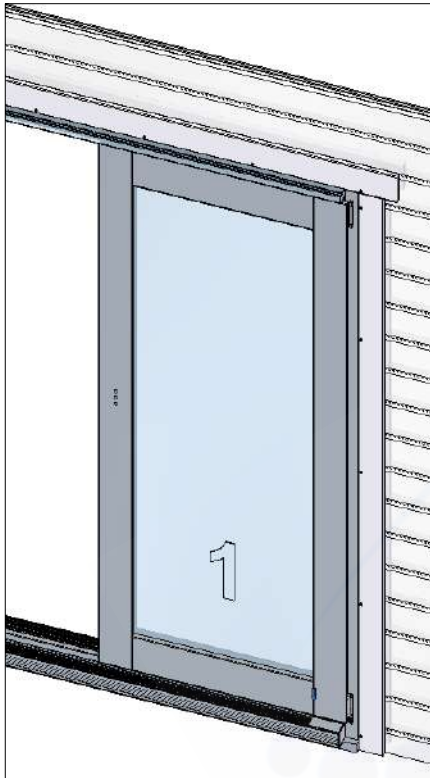

Step 1

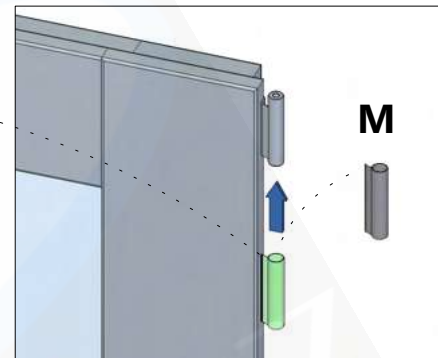

Step 2

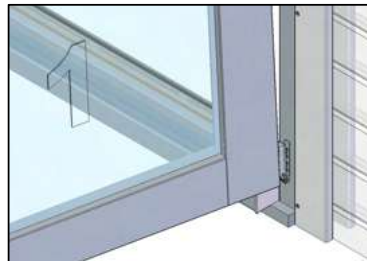
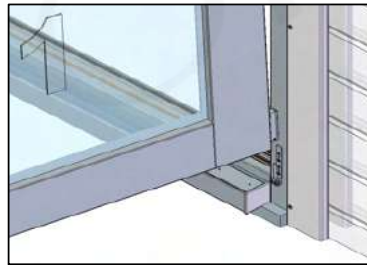
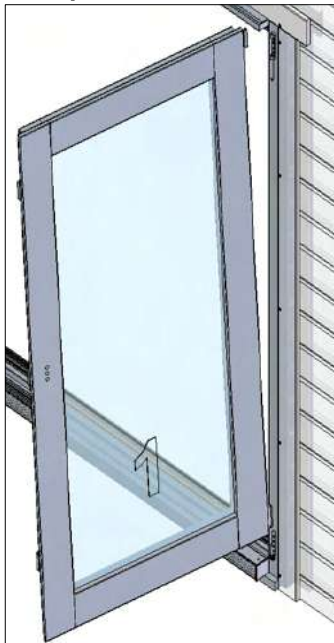

Step 3



Door sash no. 2 installation



See the page 16

- adjusting the fold and slide hinge
- see additional document *"Installation, operating and maintenance instructions"*

View from outside

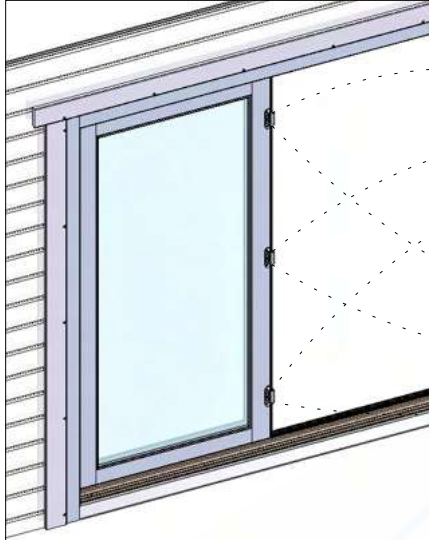

Step 1

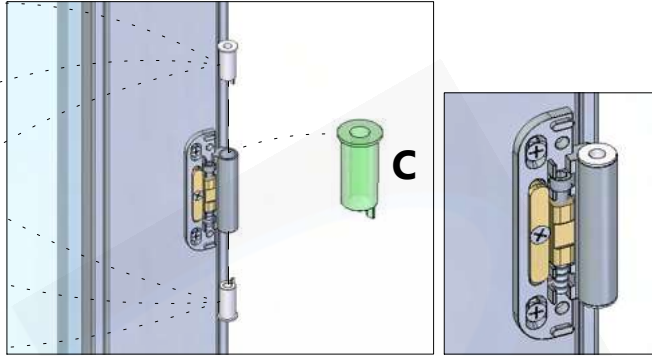

Step 2

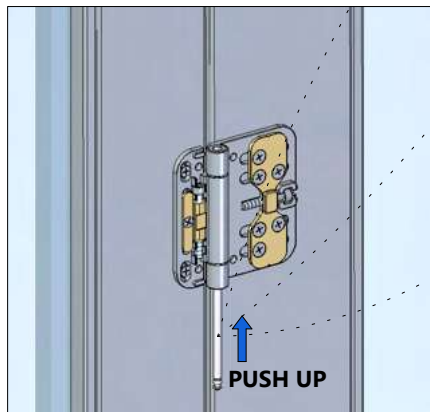

Door sash no. 2 installation continued



See the page 16

- adjusting the bogie and guide roll
- see additional document *"Installation, operating and maintenance instructions"*

View from inside



Step 3

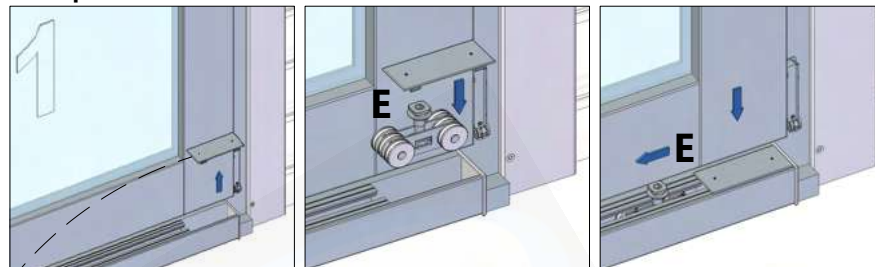

insert **I-st** lower guide roll **E**
insert **II-nd** lower guide roll **E**



remove the cap
install after adjustment

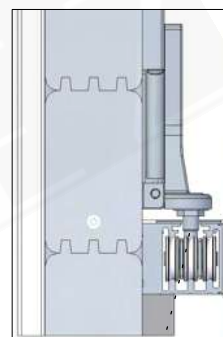
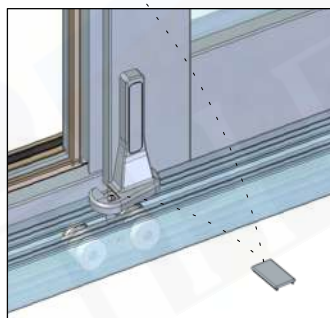
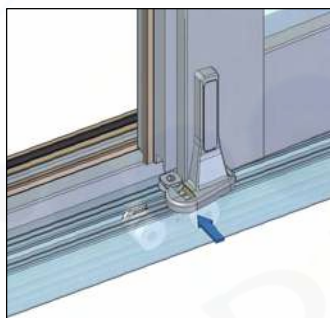
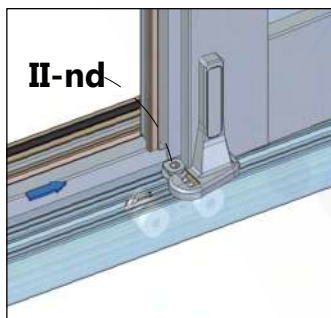

Step 4

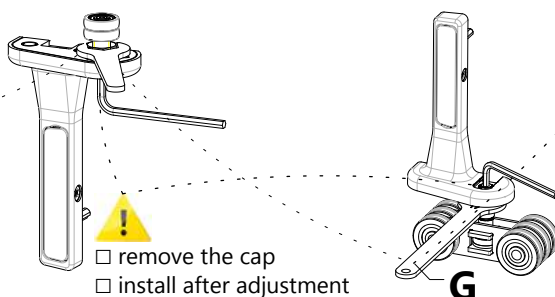
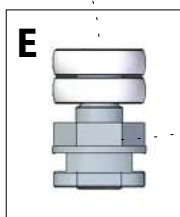
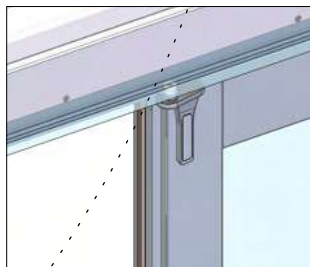
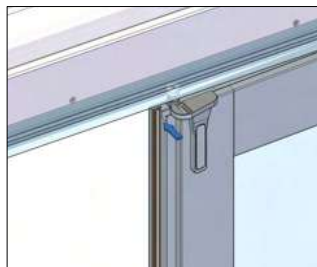
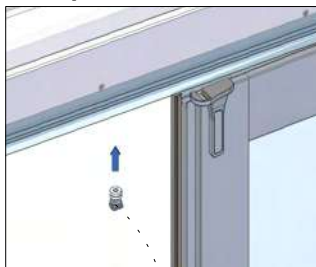

remove the cap
 install after adjustment

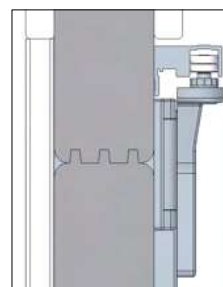

Door sash no. 3 installation



See the page 16

- adjusting the fold and slide hinge
- see additional document *"Installation, operating and maintenance instructions"*

View from inside

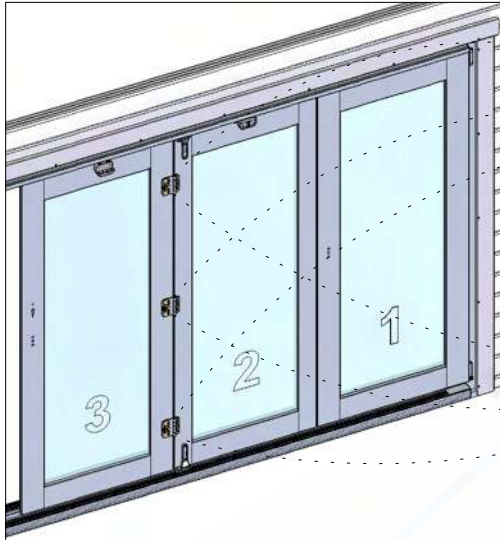

Step 1

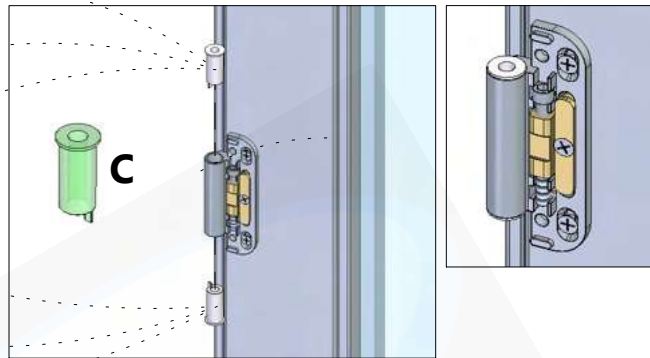

Step 2



Step 3



- adjusting the folding catch



- loosen bolts to adjust **up and down**
- tighten bolts after adjustment

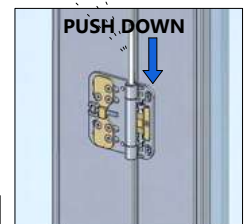
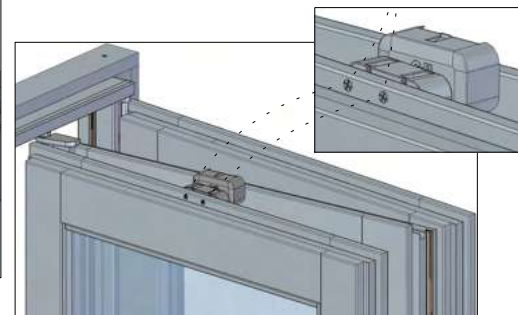

Door sash no. 5 installation



See the page 16

- engaging and disengaging the stay
- adjusting the stay
- adjustment at the rebate corner hinge
- adjusting the pivot rest

View from inside

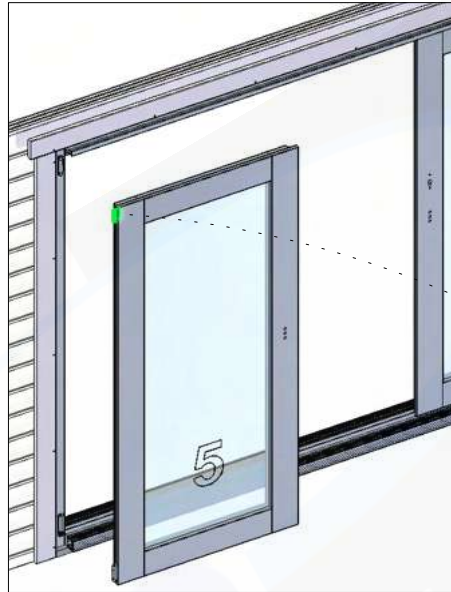

Step 1



Step 2

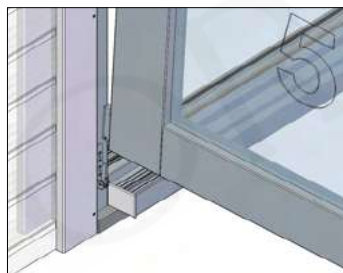
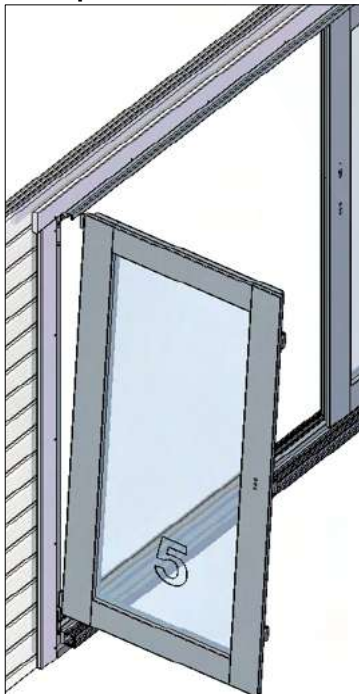

Step 3

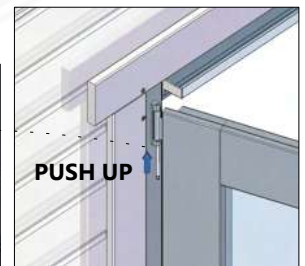
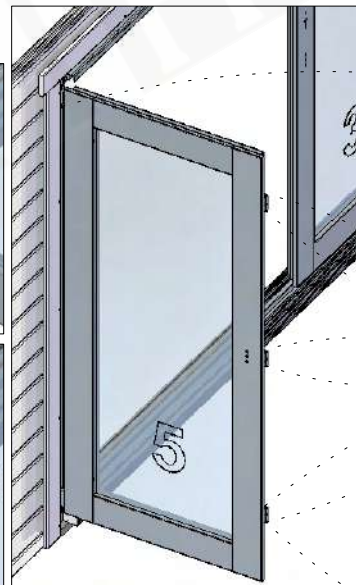

Step 4

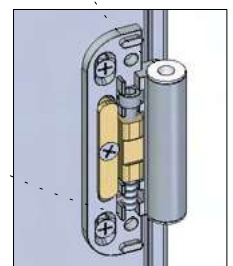
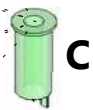

Door sash no. 4 installation



See the page 16

- adjusting the fold and slide hinge
- see additional document *"Installation, operating and maintenance instructions"*

View from inside



Step 1

Open door no. 3 to allow free space



View from outside

Step 2

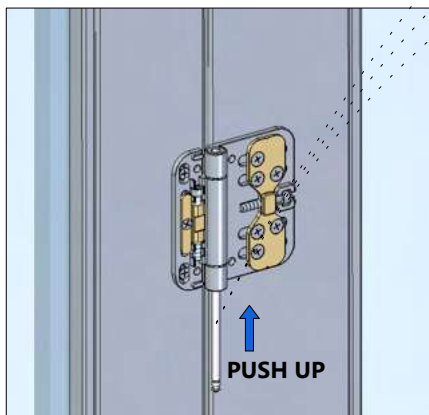
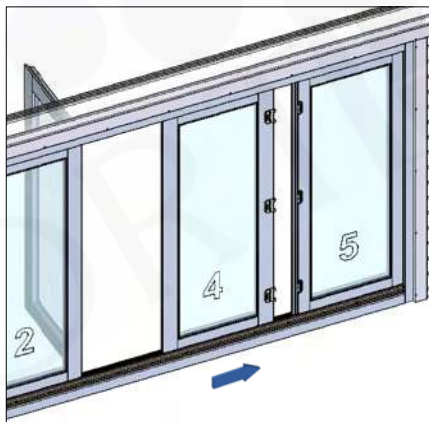

Door sash no. 4 installation continued



See the page 16

- adjusting the bogie and guide roll
- see additional document *"Installation, operating and maintenance instructions"*

View from inside



Step 3

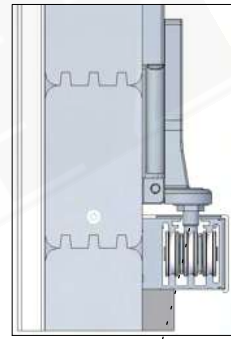
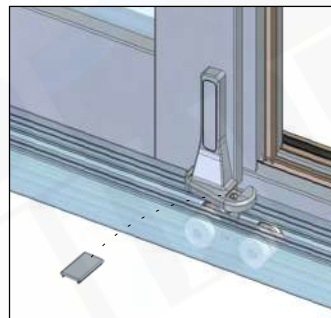
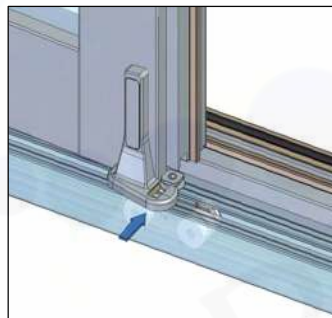
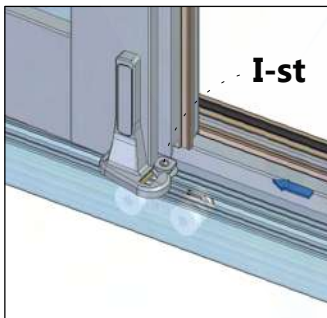
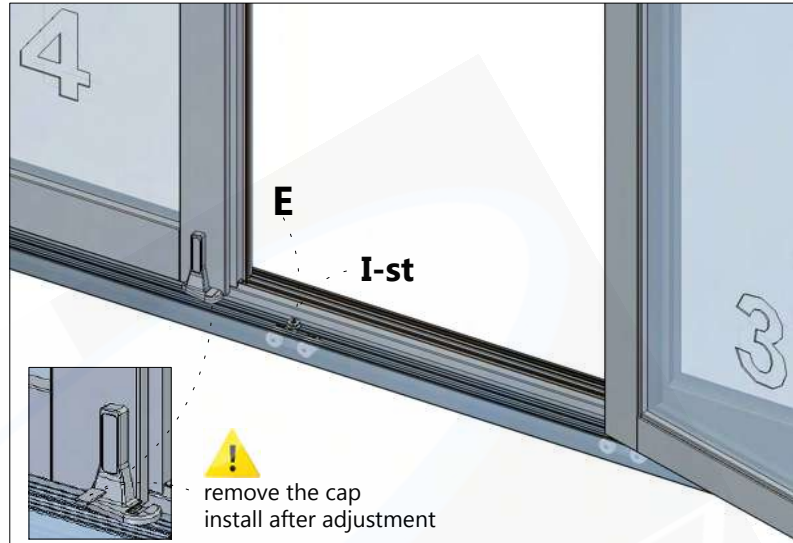

Step 4

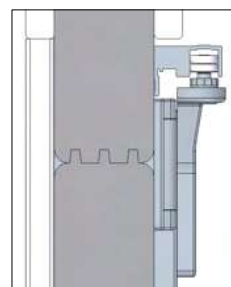
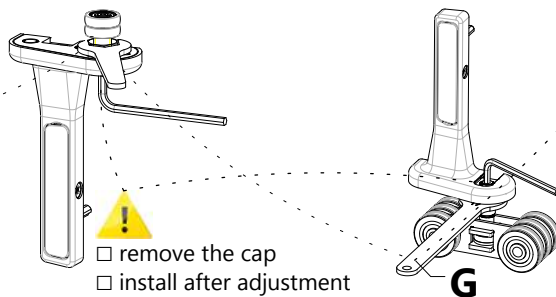
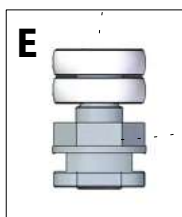
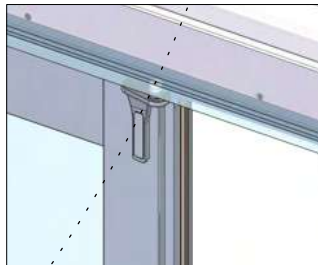
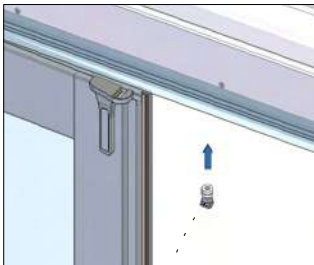

Door handles and lock set installation



Tools not supplied!

View from inside

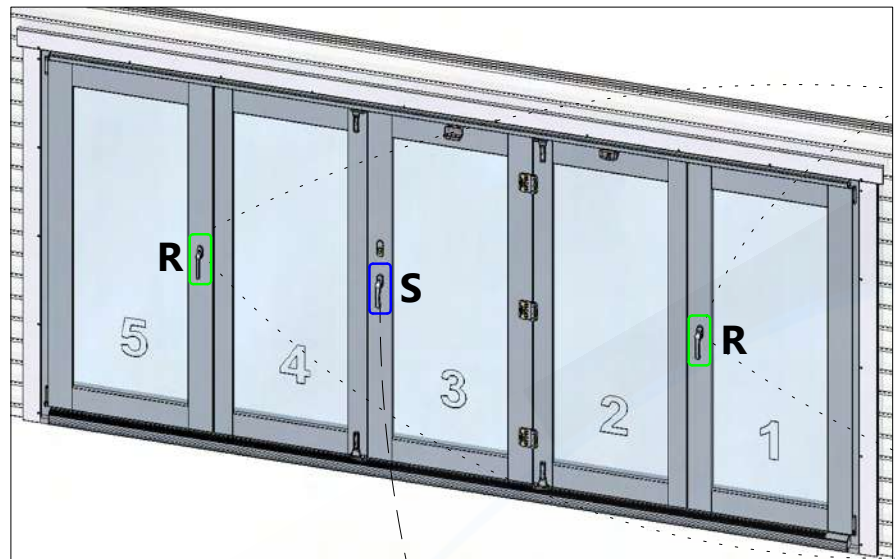

Step 1

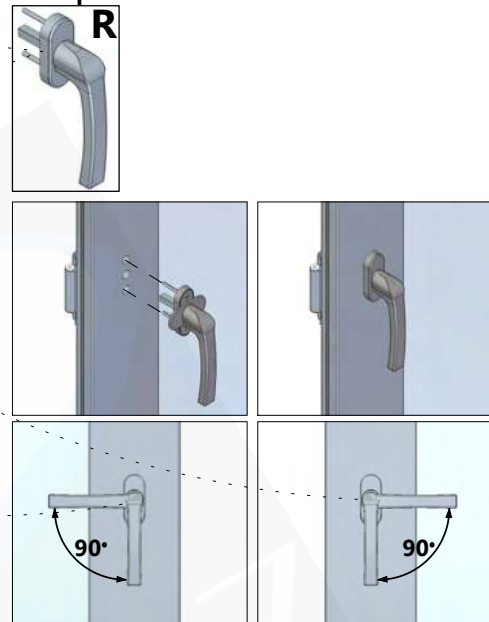

Step 2

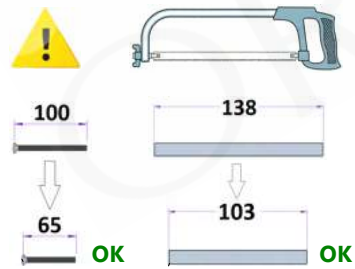
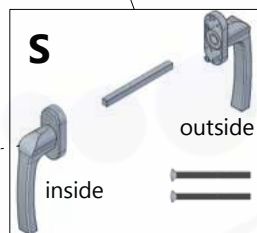

View from outside



Step 3

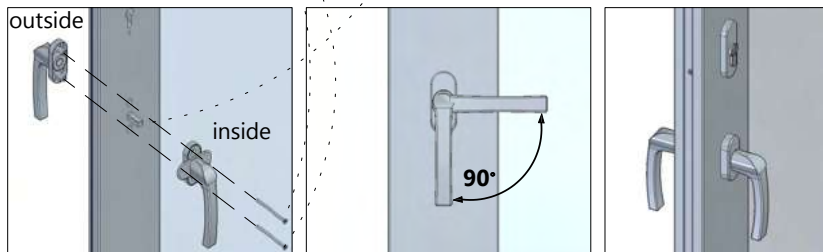
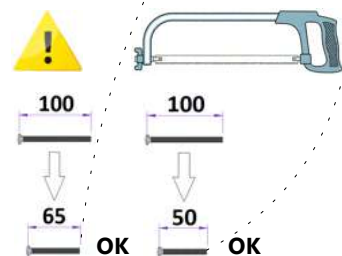
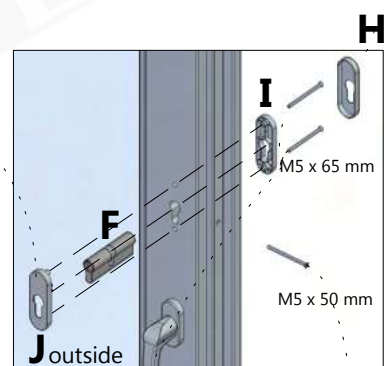

Cover caps installation

View from inside

Step 1

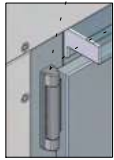
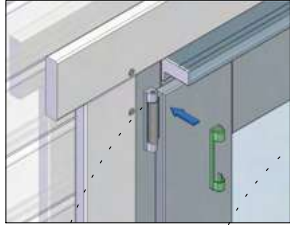

N



O (RH)



P

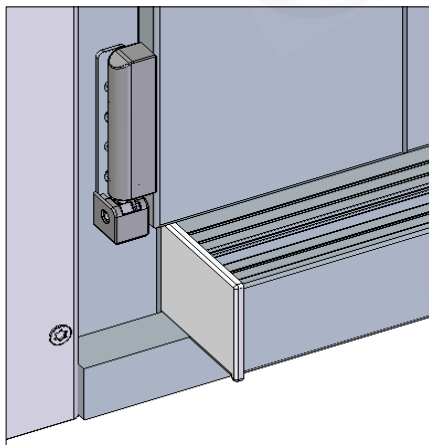
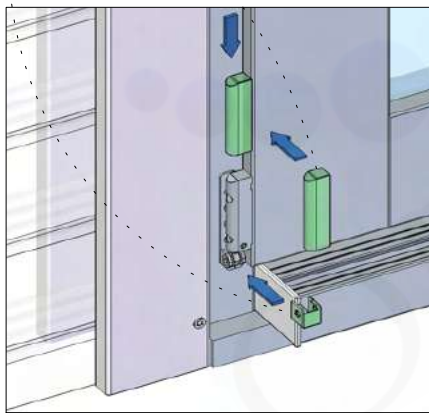

Step 2

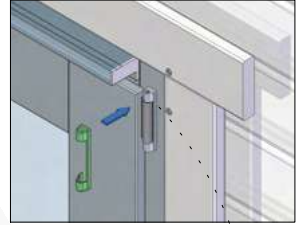

N



O (LH)



P

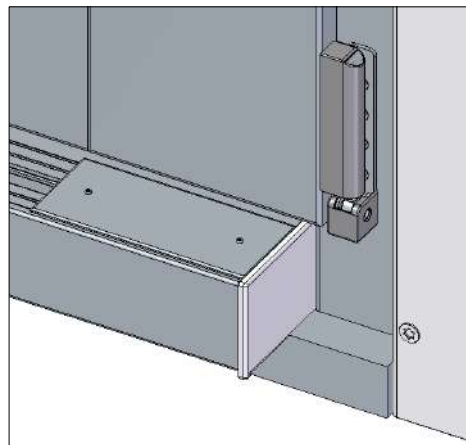
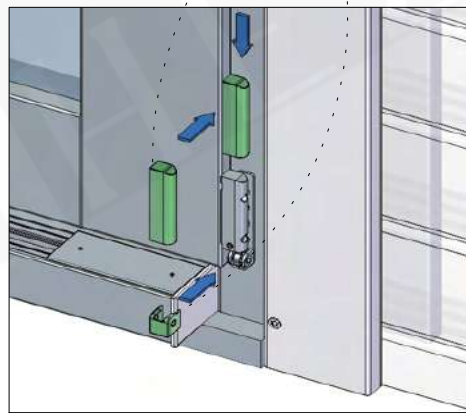

Hardware adjustment



Tools not supplied!

Engaging and disengaging the stay

Adjusting the stay
Setting + 3,5 mm / -3 mm
TX 15

Adjusting the pivot rest

Adjustment at the rebate corner-hinge

Adjusting the pivot rest



See additional document

"Installation, operating and maintenance instructions"

Vertical adjustment on bogie / pivot rest

Loosening and adjusting

- Hold the set bolt using an allen key SW 4
- Loosen and hold the locknut using an open-end spanner size 17
- Adjust vertically with Allen key SW 4

Locking

- Hold the set bolt using an Allen key SW 4
- Firmly tighten locknut with open end spanner size 17

Vertical adjustment on bogie and guide roll

Loosening and adjusting

- Hold the set bolt using an allen key SW 4
- Loosen and hold the locknut using an open-end spanner size 17
- Adjust vertically with Allen key SW 4

Locking

- Hold the set bolt using an Allen key SW 4
- Firmly tighten locknut with open end spanner size 17

Fixing / removing the sash hinge cover

For attachment / removal of sash-hinge covers, the setscrews on the back must be tightened / loosened. Open sashes to access screws, if the F&S unit is already installed.

Cover caps installation



See the page 16

- fixing / removing the sash-hinge cover
- perform same steps at interior side

Tools not supplied!

SW 2

View from outside

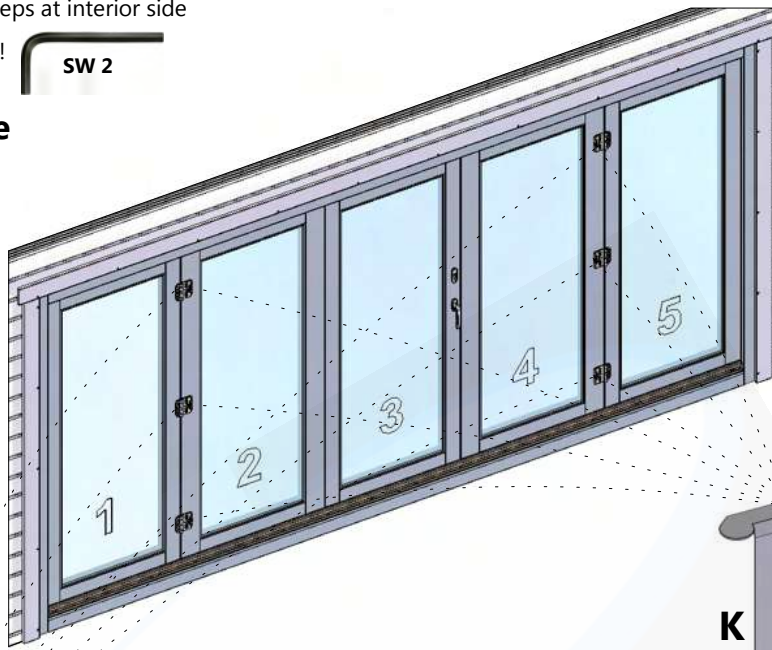

Step 1



install cover caps after fine adjustment

Step 2

L



Installing the hinge cover

■ Open the Fold&Slide system so the sashes are at roughly 90° to one another. This allows the set screws of the hinges to be accessed from the side opposite to the hinges.

■ Push the large cover from the hinge side completely onto the hinge.

■ To fasten the cover to the hinge, screw in the two set screws (see illustration) completely by turning them clockwise with a hexagon spanner.

■ Push the small cover completely onto the hinge from the hinge side.

■ To fasten the cover to the hinge, screw in the set screw (see illustration) completely by turning it clockwise with a hexagon spanner.

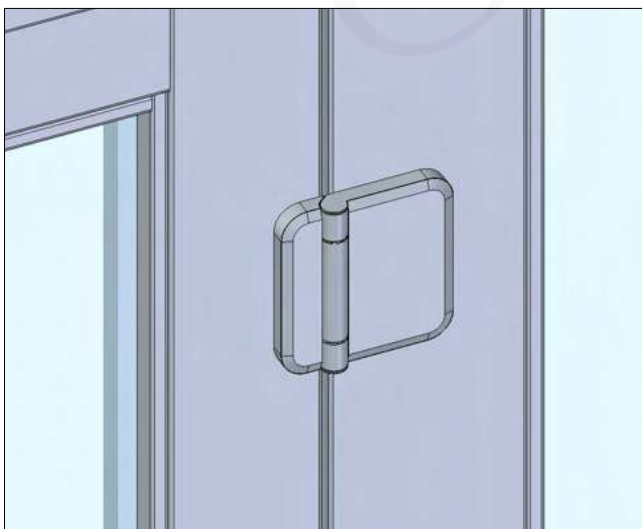
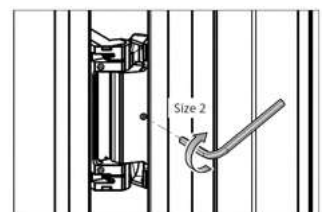
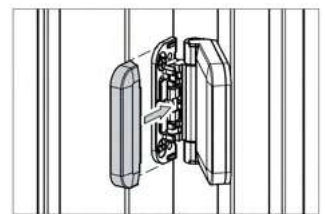
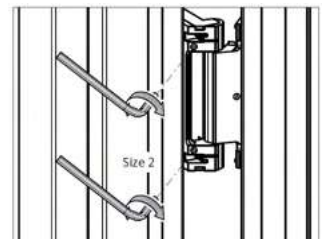
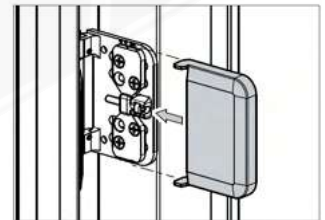

Operation of doors



- Use door 3 independently as a daily access door.
- Close door 3 by turning handle 90 degrees downwards, for locking turn the key counter clockwise.

View from inside (inward opening)

